

# EXAIR®

MANUFACTURING INTELLIGENT COMPRESSED AIR® PRODUCTS SINCE 1983



COAT



COOL



CONSERVE



CLEAN



CONVEY

# 35 CATALOG

**NEW**

- Ultrasonic Leak Detector.....pg. 18
- 1/2 NPT Hollowstream™ Cone Nozzles.....pg. 105
- Varistat Benchtop Ionizer™.....pg. 147
- ATEX Cabinet Cooler® Systems.....pg. 228



YOU REQUESTED THIS CATALOG AND PRICE LIST.  
PLEASE SEE MAILING LABEL ON BACK COVER.

Stay up to date by visiting our website and take advantage of the information and services we didn't have room to display in this catalog.



### Where you can

- Chat live with our problem solving, technical expert Application Engineers
- Watch **product videos** to learn more about the features and benefits of our engineered products
- Quickly **order online** with a purchase order or credit card (US & Canada)
- Access **product presentation slides** you can use to educate others
- Find **International Distributors** all across the world



### Access our Knowledge Base to

- Download **3D models** and CAD drawings in multiple formats to place into your drawings
- Calculate **air savings and ROI** to see how quickly EXAIR products will pay off
- Search our **Case Study Library & Applications database** and become familiar with how our products solve problems
- Use our **product FAQ's** for quick access to our most common questions
- Learn about our free **Efficiency Lab** service and use it to **determine air and money savings** you can achieve when installing EXAIR engineered solutions
- Collect compressed air data and pipe sizing recommendations
- Find **Flow, Force and Heat conversions**



### Visit our PDF library and download

- Electronic files of the **entire catalog** or individual sections
- **Installation and Maintenance Guides** on every EXAIR product
- Our current **price list** to have all product prices in one convenient location
- EXAIR's **Air Nozzle Blowoff Guide** to see the details on our enormous selection of sizes, materials and performance options



### Follow our blog for 5 new entries a week and learn

- Details and installations of widely varied applications
- The methodology and results of critical mathematical formulas which help determine money savings, air savings, performance benefits and more
- New product releases before they reach our catalog or website
- More about EXAIR, our team and community involvement
- Go to [blog.exair.com](http://blog.exair.com)



### Make social connections

- Watch over **150 videos** on EXAIR's YouTube Channel and see product features and benefits, applications, Tips & Tricks, How-to, and our team members.
- Follow our Company on Twitter @EXAIR or our Application Engineers and learn more about promotions, updates on manufacturing, engineering and international industry perspective.



- Connect with us on Facebook at [facebook.com/exair](http://facebook.com/exair) or follow us on Linked In, Twitter and Instagram.

**Not on a PC? Our website is mobile friendly**

# Terms and Conditions (U.S. and Canada Only)

**Terms:** Net 30 days upon credit approval, Visa, MasterCard, Discover and American Express.



**ICC (International Chamber of Commerce) INCOTERM 2010:**

EX WORKS (EXAIR, 11510 Goldcoast Dr., Cincinnati, Ohio 45249, USA.)

**Delivery**

All cataloged products are shipped from stock, via U.P.S. within 24 hours after receipt of order. Priority shipment is available upon request.

**Ordering:**

Call 1-800-903-9247 or +1-513-671-3322      Worldwide 7:00 a.m. to 4:00 p.m. ET (Mon. - Fri.)  
Fax toll free 1-866-329-3924 or      Worldwide +1-513-671-3363  
E-mail: orders@exair.com      Secure website: www.exair.com

**Remit to address (payments only):**

EXAIR Location 00766, Cincinnati, Ohio 45264-0766

**Tax:**

Sales and use tax, where applicable, are not included.

**Technical Assistance:**

Please call our Application Engineering Department, 1-800-90-EXAIR (1-800-903-9247) e-mail at techhelp@exair.com.



**Warranty:**

5 Year "Built To Last" Warranty against defects in workmanship and materials on all compressed air products\*. Defective products must be returned freight prepaid for repair or replacement at our option. This warranty applies under conditions of normal use, but does not apply to defects that result from intentional damage, negligence, unreasonable use, wear or exposure.

\*5 Year Warranty applies to compressed air products only. A 1 Year Warranty applies to all accessories and electrically powered products.

**EXAIR's Unconditional Guarantee:**

Extends to all U.S. and Canadian customers and includes invoiced U.P.S. Ground Service shipping charges. Products returned after the 30 day guarantee period are subject to a 15% restocking charge. Products must be returned freight prepaid.



**Copyright Restrictions:**

The content of the EXAIR Catalog, including all photos, graphics, drawings and arrangements are proprietary to EXAIR LLC and are protected by the United States and international copyright and trademark laws. You are authorized to use the contents of the EXAIR Catalog for personal use or as it relates to your role as a current or prospective customer of EXAIR. The contents of this catalog may not be copied or modified for any type of publication or distribution without the prior written consent of EXAIR. The content of the EXAIR Catalog is the intellectual property solely of EXAIR with no rights transferred to other parties. No part of this catalog may be reproduced for any commercial purposes without the express authorization in writing by EXAIR.

**Trademarks:**

"EXAIR.com", "EXAIR", "Cabinet Cooler", "E-Vac", "Intelligent Compressed Air", "VariBlast", "Gen4", "Intellistat", "EasySwitch", "TurboBlast", "Varistat" and "Compressed Air Intelligence" are registered trademarks of the EXAIR LLC. The EXAIR logo, product names, designs and descriptive phrases are trademarked by EXAIR. These trademarks may not be used without prior written permission of EXAIR.

**EXAIR.com**

11510 Goldcoast Dr.  
Cincinnati, Ohio 45249-1621  
**Phone Number:** (513) 671-3322  
**Fax Number:** (513) 671-3363  
**E-mail:** techhelp@exair.com  
**Web Site:** www.exair.com

EXAIRLogger, EFC, Digital Flowmeter, Hot Tap Digital Flowmeter, Digital Sound Level Meter, High Power Cold Gun, Super Air Knife, Standard Air Knife, Full-Flow Air Knife, Air Cannon, Super Air Amplifier, Adjustable Air Amplifier, Super Air Nozzle, Micro Air Nozzle, High Power Safety Air Nozzle, Stay Set Hose, Soft Grip Super Air Scraper, Super Air Scraper, Super Blast Safety Air Gun, Super Air Wipe, Heavy Duty Line Vac, Light Duty Line Vac, Sanitary Flange Line Vac, Threaded Line Vac, FullStream, FloodStream, HollowStream, Standard Air Wipe, Super Ion Air Knife, Standard Ion Air Knife, Super Ion Air Wipe, Ion Air Cannon, Ion Air Gun, Ion Air Jet, Ionizing Point, Stay Set Ion Air Jet, Line Vac, Chip Vac, Heavy Duty Dry Vac, Heavy Duty HEPA Vac, Reversible Drum Vac, High Lift Reversible Drum Vac, Chip Trapper, High Lift Chip Trapper, Vac-u-Gun, Deep Hole Vac-u-Gun, Air Disk, Air Stik, Mini Cooler, Cold Gun Aircoolant System, and ETC are trademarks of EXAIR LLC.



Intelligent Compressed Air® products are identified throughout this catalog that can help your plant save tens of thousands of dollars over the course of a single year. *The Best Practices for Compressed Air Systems*; manual published by the Compressed

Air Challenge® recommends products like the Super Air Knife™, Super Air Amplifier™, and the family of Super Air Nozzles™ for energy conservation. Many of the products shown offer unique ways to solve common industrial problems using compressed air. Compressed Air Challenge is a registered trademark of Compressed Air Challenge, Inc.



EXAIR has partnered with Energy Star, a voluntary program of the U.S. Department of Energy and the Environmental Protection Agency. Energy Star offers energy efficient solutions to help save money while protecting the environment for future generations. EXAIR has implemented improved energy management practices and technologies throughout our facility, including energy efficient lighting, HVAC systems, and electronic thermostats. EXAIR's participation in this program underscores our commitment to conserving energy.

EXAIR products are subject to ongoing development. Specifications are subject to change without notice.

Some products in this catalog are covered by U.S. Patent #5402938, #8153001, #8268179, #D903,817, #10,779,698 and #9156045, and others may be U.S. Patent Pending. EU Regd. Des. No.00770318-0001 and No. 009025463-0001 © Mexico No.60723; Canada No.194141, UK Registered Design No. 6211314

Copyright ©2023 EXAIR LLC. All Rights Reserved.



@EXAIR



## Air Amplifiers

Vent, exhaust, cool, dry, clean – with no moving parts!

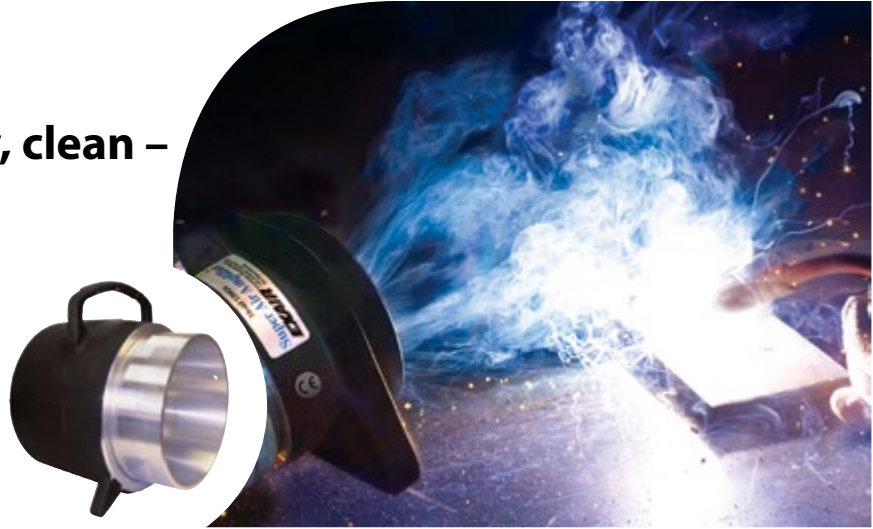

### What Are Air Amplifiers?

A simple, low cost way to move air, smoke, fumes, and light materials. Air Amplifiers utilize the Coanda effect, a basic principle of fluid dynamics, to create air motion in their surroundings. Using a small amount of compressed air as their power source, Air Amplifiers pull in large volumes of surrounding air to **produce high volume, high velocity outlet flows. Quiet, efficient Air Amplifiers will create output flows up to 25 times their consumption rate.**

### Why Air Amplifiers?

Air Amplifiers have no moving parts, assuring maintenance-free operation. No electricity is required. Flow, vacuum and velocity are easy to control. Outlet flows are easily adjusted by opening or closing the air gap. Supply air pressure can be regulated to fine tune outlet flow to meet application needs.

Both the vacuum and discharge ends of the Air Amplifier can be ducted, making them ideal for drawing fresh air from another location, or moving smoke and fumes away.



A series of Model 6042 2" (51mm) Adjustable Air Amplifiers blow coolant off 16 cylinder diesel engines.

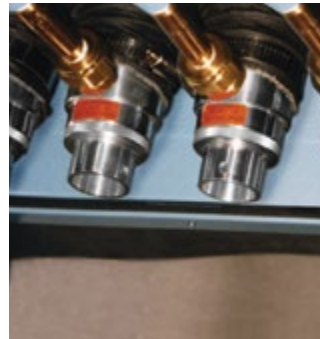

Adjustable Air Amplifiers are ducted to draw clean air for drying.



A Model 120024 4" (102mm) Super Air Amplifier cools an engine during dynamometer testing.

### Applications

- Vent welding smoke
- Cool hot parts
- Dry wet parts
- Clean machined parts
- Distribute heat in molds/ovens
- Ventilate confined areas
- Dust collection
- Exhaust tank fumes

### Advantages Compared to Fans:

- Compact, lightweight, portable
- No electricity
- No moving parts – no maintenance
- Ends are easily ducted
- Instant on/off
- Variable force and flow
- No RF interference

### Compared to Venturis and Ejectors:

- More air volume with lower compressed air consumption
- Higher flow amplification
- No internal obstructions
- Meets OSHA pressure and noise requirements
- Quiet

## How Air Amplifiers Work

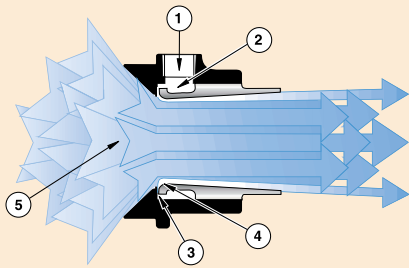

Compressed air flows through the air inlet (1) into an annular chamber (2). It is then throttled through a small ring nozzle (3) at high velocity. This primary airstream adheres to the Coanda profile (4), which directs it toward the outlet. A low pressure area is created at the center (5), inducing a high volume flow of surrounding air into the primary airstream. The combined flow of primary and surrounding air exhausts from the Air Amplifier in a high volume, high velocity flow.

## Air Amplifier Model Selection Guide

	Air Amplifier Comparison					
	Efficiency	Sound Level	Mounting Flange	Flow Adjustment	Temp. Rating	Corrosive Applications
Super Air Amplifier	High	Low	Yes	With Shims	275°F (135°C)	No
Aluminum Adjustable Air Amplifier	Medium	Variable	No	Infinite (No shims)	275°F (135°C)	No
Stainless Steel Adjustable Air Amplifier	Medium	Variable	No	Infinite (No shims)	400°F (204°C)	Yes
High Temperature Air Amplifier	High	Low	No	With Shims	700°F (374°C)	Yes

## Special Air Amplifiers

EXAIR will manufacture special Air Amplifiers suited to your specific application requirements. The Model 121021 High Temperature Air Amplifier (shown top right) was developed for moving hot air to surfaces requiring uniform heating while in a furnace or oven. Modeled after our Super Air Amplifier, the High Temperature Air Amplifier is the most efficient for pushing high volumes of hot air to points that typically remain cool. This special design is rated for environments up to 700°F (374°C) and its surface is protected from heat stress by a mil-spec. coating process (developed for the aircraft industry), allowing easy disassembly for changing shims or cleaning.

Another stainless steel version for flange mounting was developed as a fan back-up for exhausting flue gases from a furnace (shown middle right). In the event of a power failure, this special Air Amplifier can quickly evacuate the fumes that could be harmful to workers close by.

A PTFE plug was used with a stainless steel Adjustable Air Amplifier (shown bottom right) to help pull a sticky material through a process and prevent the material from depositing on the Air Amplifier.

EXAIR's Intelligent Compressed Air® products can be manufactured to your special requirements.

**If you have special requirements, please contact an Application Engineer to discuss your application.**



A Model 121021 1-1/4" (32mm) High Temperature Air Amplifier directs hot air to a rotational mold cavity for uniform wall thickness of the plastic part.



This special stainless steel flange-mount Air Amplifier was designed for exhausting hot flue gases from a furnace.



Adjustable Air Amplifier with PTFE plug helped pull a sticky material through a process and prevented the material from depositing on the Air Amplifier.

## Super Air Amplifier™

Powerful, efficient and quiet air mover for blowoff, cooling, and ventilation.



Air Amplifiers

### What Is The Super Air Amplifier?

EXAIR's Super Air Amplifier has a patented\* design that uses a special shim to maintain critical position of the component parts. As a result, a precise amount of compressed air is released at exact intervals toward the center of the Super Air Amplifier. These jets of air create a constant, high velocity outlet flow across the entire cross-sectional area. Additional free air is pulled through the unit, resulting in higher amplification ratios. The balanced outlet airflow

minimizes wind shear to produce sound levels that are typically three times quieter than other air movers.

Super Air Amplifiers are supplied with a .003" (0.08mm) slotted air gap which is ideal for most applications. Flow and force can be increased by replacing the shim with a thicker .006" (0.15mm) or .009" (0.23mm) shim. Model 120028 is supplied with a .009" (0.23mm) air gap. A .015" (0.39mm) shim is available for Model 120028.

### Super Air Amplifier Performance at 80 PSIG (5.5 BAR)

Model #	Air Consumption		Amplification	Air Volume at Outlet		Air Volume at 6" (152mm)		Sound Level
	SCFM	SLPM	RATIO	SCFM	SLPM	SCFM	SLPM	
120020	6.1	173	12	73	2,066	219	6,198	69
120021	8.1	229	18	146	4,132	436	12,339	72
120022	15.5	439	22	341	9,650	1,023	28,951	72
120024	29.2	826	25	730	20,659	2,190	61,977	73
120028	120	3,396	25	3,000	84,900	9,000	254,700	88

Model 120028 tested with .009" (0.23mm) shim. All other models tested with .003" (0.08mm) shim.



Model 120022 2" (51mm) Super Air Amplifiers and Model 1122 2" Flat Super Air Nozzles blow off transmissions after they are machined.



(2) Model 120022 2" (51mm) Super Air Amplifiers dry small parts as they move down along a parts conveyor.



(5) Model 120022 2" (51mm) Super Air Amplifiers cool truck pistons.

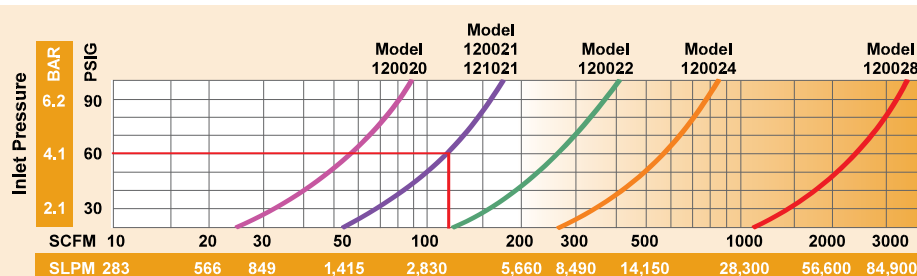

Total Output Flow with .003" (0.08mm) thick shim installed. Excludes downstream entrainment. Model 120028 tested with a .009" (0.23mm) shim.

### How To Determine Super Air Amplifier Total Output Flow And Air Consumption

**Total Airflow:** From the performance curves (above), determine total output flow for any Super Air Amplifier at any pressure.

**Example:** A Model 120021 at 60 PSIG (4.1 BAR) supply air pressure has a total output flow of 120 SCFM (3,398 SLPM).

**Air Consumption:** Divide the total output flow by the amplification ratio (shown in the chart) to determine air consumption for any Super Air Amplifier at any air pressure.

In the example above, the Model 120021 at 60 PSIG (4.1 BAR) supply air pressure has a total output flow of 120 SCFM (3,398 SLPM). Dividing this total output flow by its amplification ratio of 18 gives an air consumption of 6.7 SCFM (189 SLPM).

\*Patent #5402938

## Blowoff On A Transmission Pan

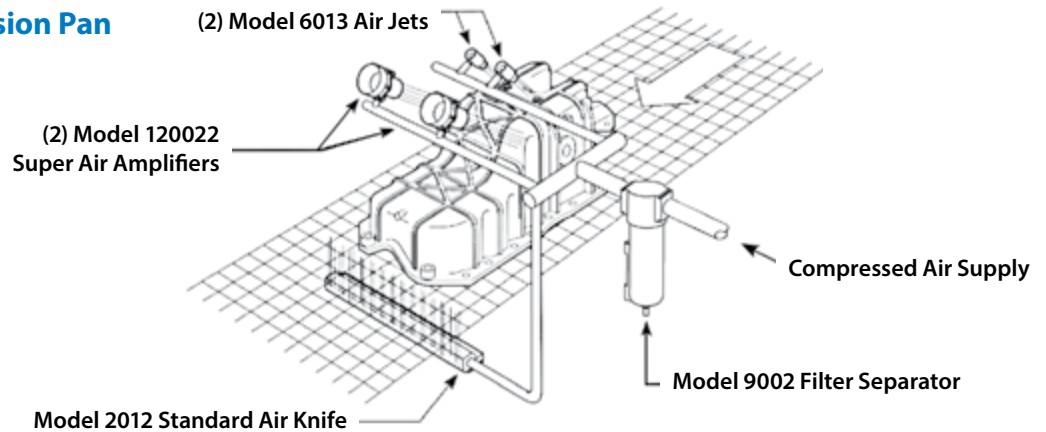

**The Problem:** A newly designed transmission pan presented a myriad of cleaning problems for the die-caster. Because the configuration included channels and blind holes as well as smooth surfaces, a “shaped” air pattern was required for proper cleaning. No single blowoff product would fit the need. An assortment of open copper tubes and drilled pipes was considered, but was rejected as too noisy and expensive to operate. A blower was not an option due to the high purchase price, expensive maintenance costs and frequent downtime.

**The Solution:** With help from our Application Engineers, the company created a cleaning system incorporating a variety of EXAIR blowoff products. **(2) Model 6013 High Velocity Air Jets**, with their confined airstream,

cleared the blind holes, while **(2) Model 120022 2" (51mm) Super Air Amplifiers** cleaned the channels. A **Model 2012 12" (305mm) Standard Air Knife** was positioned to blow out the casting's underside.

**Comment:** There's no doubt that the casting could have been cleaned just as well by hooking up a bunch of open copper tubes and throwing a ton of air at it. But, at what cost? EXAIR makes a variety of blowoff products because parts come in a variety of shapes and sizes. **And, our products operate at a fraction of the air consumption and noise levels associated with open air pipes.** When you need to clean, cool, or dry with air, and you'd like to minimize dollars and decibels, EXAIR can help.

## Super Air Amplifier Cools Iron Castings

**The Problem:** A foundry that produces iron castings for the automotive industry had a problem with certain hot parts that slowed their production. After pouring, the castings gradually cool by traveling along a 200 foot long conveyor. At the end, a shake-out conveyor breaks the sand mold so the casting can be removed. Normally, the operator could pick up the part with special gloves and grind the rough edges. However, some castings such as crankshafts, differential housings, and shift parts retained too much heat, making them too hot to handle. The operator had to wait up to ten minutes for them to cool.

**The Solution:** They installed **(5) Model 120022 2" (51mm) Super Air Amplifiers** over the shake-out conveyor. The high output airflow from each Super Air Amplifier rapidly cooled the parts without shocking them (no cracks or imperfections from cooling too rapidly). **When the part reached the end of the conveyor, the operator could proceed immediately.** The backlog was completely eliminated.

**Editor's Comment:** This manufacturer had almost given up on finding a cooling solution since the fans and blowers that were tried in the past showed little improvement. Our Super Air Amplifier dramatically reduced the cooling time. As a result, they installed them on their second line. The low cost Super Air Amplifiers are compact, portable and have no moving parts to wear out (which is ideal in a dusty foundry). **And, the patented design assures the highest output air volumes possible with the lowest air consumption.**

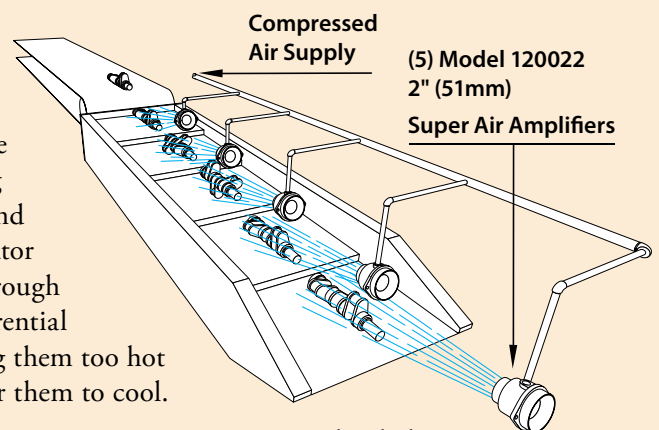

# Super Air Amplifiers

## Roaring Banana Breath

Air Amplifiers

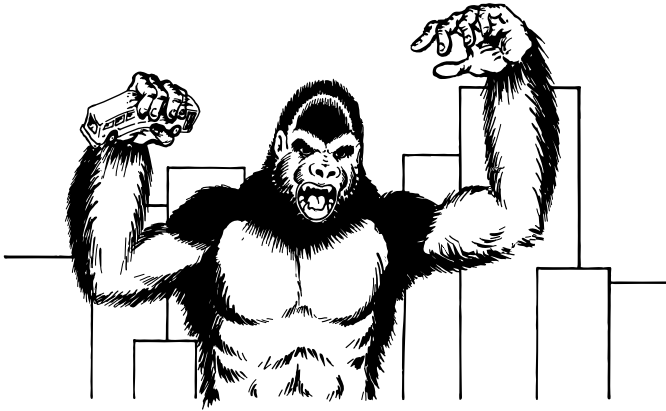

**The Problem:** A company that designs major attractions for theme parks created a huge gorilla to startle the patrons. The animators wanted the oversized ape to appear as “life-like” as possible. To accomplish this, they used a series of motors and cylinders to make the movement of the eyes, hands, arms and torso appear realistic. They also installed a large speaker system to play an audio sample of a loud roar that matched his mammoth size. The finishing touch was to find a way to create a powerful blast of air that smelled like bananas each time the big ape’s mouth opened. Attempts using an electrically powered blower proved unsuccessful due to the noise and the inability to obtain an “instant on” blast of air.

**The Solution:** They installed a tank of banana extract in his tummy and connected it to his mouth with a **Model 120028 8" (203mm) Super Air Amplifier**. As the spectators moved into position, a sensor activated the electronics, setting “Old Banana Breath” (name given by the designers) into motion. With a swift movement toward the crowd, his mouth opens and **the Super Air Amplifier provides an instantaneous blast of high velocity air (filled with banana fumes) at them.**

**Comment:** Why did the engineers select the Super Air Amplifier? First, simplicity. There are no moving parts to wear out or require maintenance. It uses only filtered compressed air as the power source. Second is the big instantaneous blast of high volume, high velocity airflow that couldn't be obtained using a blower or air nozzles. When it comes to special effects, Super Air Amplifiers are the way to go. When you watch the movies or visit the theme parks and see fast moving fog, smoke effects, or objects flying through the air, chances are a Super Air Amplifier is being used.

## Cleaning Brake Rotors

**The Problem:** An automotive machine shop that manufactures brake rotors was having problems with chip build-up inside the part. They tried compressed air tubing flattened on their ends with little success. This resulted in high compressed air usage, high sound levels, and danger to their employees.

**The Solution:** A **Model 120021 1-1/4" (32mm) Super Air Amplifier** was substituted for the tubing. It provided a larger pattern of air, used less compressed air, the sound level was substantially lower, and it couldn't be dead ended.

**Comment:** Bent tubing or drilled pipe are inexpensive and easy to make. However, the initial cost is overshadowed by its high energy use; holes can be blocked and noise level is excessive – both of which are OSHA violations. EXAIR's Super Air Amplifiers are compact and dependable since there are no parts to wear out. Our patented design moves the most airflow possible while using the smallest amount of compressed air. The lower sound level was another bonus!

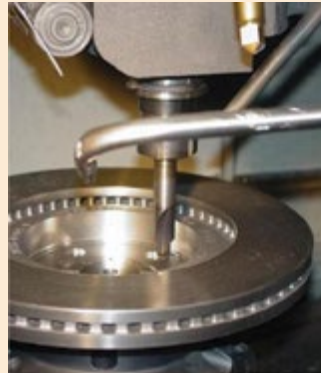

### The Problem:

**Model 120021 1-1/4" (32mm) Super Air Amplifier blows off parts and lowers sound levels.**



### The Solution:



# Super Air Amplifiers

## Super Air Amplifier Dimensions

Super Air Amplifier Dimensions													
Model #		A	B	C	D	E	F	G	H	J	K	L	M
120020	in	0.45	0.75	0.98	1.77	2.28	0.20	0.18	0.53	0.73	2.50	0.59	1/8 NPT
	mm	11	19	25	45	58	5	5	13	19	64	15	
120021	in	0.84	0.94	1.50	2.40	3.03	0.27	0.21	0.75	1.22	2.88	0.59	1/4 NPT
	mm	21	24	38	61	77	7	5	19	31	73	15	
120022	in	1.64	1.69	2.95	3.58	4.14	0.27	0.25	0.75	2	3	0.62	3/8 NPT
	mm	42	43	75	91	105	7	6	19	51	76	16	
120024	in	3.02	2.81	4.91	6.89	8.42	0.55	0.55	1.75	3.97	4.75	0.94	1/2 NPT
	mm	77	71	125	175	214	14	14	44	101	121	24	
120028	in	6.20	4.50	9	---	11.25	---	---	2.44	8	8.94	2.38	3/4 NPT
	mm	157	114	229	---	286	---	---	62	203	227	60	

DOWNLOAD drawings at EXAIR.com

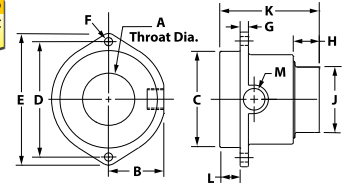

Model 120020-120024

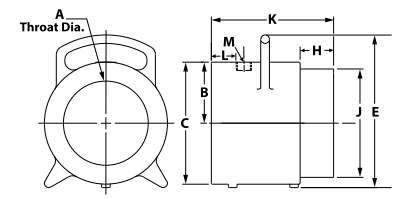

Model 120028

Air Amplifiers

## Airflow Pattern

Models 120020, 120021, 120022, 120024

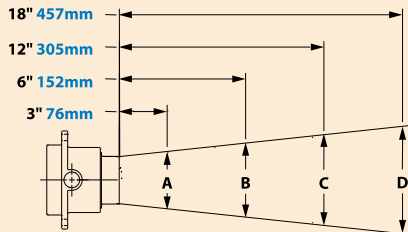

Model #		A	B	C	D
120020	in	1.25	2.2	4.1	6
	mm	32	56	104	152
120021	in	2	2.9	4.7	6.5
	mm	51	74	119	165
120022	in	2.75	3.55	5.15	6.75
	mm	70	90	131	171
120024	in	4.5	5.3	6.9	8.5
	mm	114	135	175	216

## Airflow Pattern

Model 120028

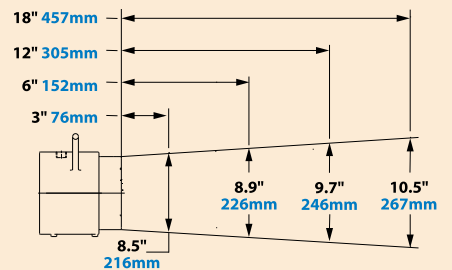

## Super Air Amplifier Models

### Super Air Amplifier Only

### Super Air Amplifier Kits -

include a Super Air Amplifier, shim set, filter separator and pressure regulator (with coupler).

### Deluxe Super Air Amplifier Kits -

include a Super Air Amplifier, EFC, shim set, filter separator and pressure regulator (with coupler).

### Super Air Amplifier Shim Sets -

include (1) .006" (0.15mm) and (1) .009" (0.23mm) stainless steel shims (except 8" which include (1) .015" (0.39mm) stainless steel shim).

Outlet Diameter	Super Air Amplifier Only Model	Super Air Amplifier Kit Model	Deluxe Super Air Amplifier Kit Model	High Temperature Air Amplifier Only Model	High Temperature Air Amplifier Kit Model	Super Air Amplifier Shim Set Model
3/4" (19mm)	120020	120220	120220DX	N/A	N/A	120320
1-1/4" (32mm)	120021	120221	120221DX	121021	121221	120321
2" (51mm)	120022	120222	120222DX	N/A	N/A	120322
4" (102mm)	120024	120224	120224DX	N/A	N/A	120324
8" (203mm)	120028	120228	120228DX	N/A	N/A	120328



Kits include a Super Air Amplifier, shim set, filter separator and pressure regulator (with coupler).

**GO GREEN** Order EXAIR's EFC™ electronic flow control to minimize compressed air use. **SAVE MONEY** See page 7 for details.

**Order Direct**  
We Ship From Stock

**ORDER ONLINE**  
at EXAIR.com

## Accessories

Model #	Description
9001	Auto Drain Filter Separator, 3/8 NPT, 65 SCFM (1,841 SLPM)
9032	Auto Drain Filter Separator, 1/2 NPT, 90 SCFM (2,549 SLPM)
9002	Auto Drain Filter Separator, 3/4 NPT, 220 SCFM (6,230 SLPM)
9005	Oil Removal Filter, 3/8 NPT, 15-37 SCFM (425-1,048 SLPM)
9006	Oil Removal Filter, 3/4 NPT, 50-150 SCFM (1,416-4,248 SLPM)
9008	Pressure Regulator with Gauge, 1/4 NPT, 50 SCFM (1,416 SLPM)
9033	Pressure Regulator with Gauge, 1/2 NPT, 100 SCFM (2,832 SLPM)
9009	Pressure Regulator with Gauge, 3/4 NPT, 220 SCFM (6,230 SLPM)



11510 Goldcoast Drive • Cincinnati, OH 45249-1621 • Phone (513) 671-3322  
FAX (513) 671-3363 • E-mail: techhelp@exair.com • www.exair.com

**Order Direct**  
We Ship From Stock

## Adjustable Air Amplifier™

Highly effective air mover that easily adjusts to your application!



Air Amplifiers

### What Is The Adjustable Air Amplifier?

The air gap is infinitely adjustable which regulates the consumption and outlet flow from a “breeze” to a “blast”. They are available in aluminum or in stainless steel for food service, higher temperatures (400°F/204°C), and corrosive applications. High Temperature Stainless Steel Air Amplifiers for temperatures up to 700°F (374°C) are also available. Please contact an Application Engineer.

Force and flow for the Adjustable Air Amplifier is changed by turning the exhaust end (with the knurled ring loose) to open or close the continuous air gap. When desired performance is obtained, the knurled ring can be tightened to lock the flow at that setting. In most cases, a .002" to .004" (0.05mm to 0.10mm) air gap is ideal.

### Adjustable Air Amplifier Performance at 80 PSIG (5.5 BAR)

Model #	Air Consumption		Amplification RATIO	Air Volume at Outlet		Air Volume at 6" (152mm)		Sound Level dBA
	SCFM	SLPM		SCFM	SLPM	SCFM	SLPM	
6030, 6040	8.9	252	10	89	2,520	267	7,560	78
6031, 6041	12.9	365	16	206	5,833	618	17,500	81
6032, 6042	21.5	608	20	430	12,176	1,290	36,529	82
6033, 6043	35.2	997	22	774	21,917	2,323	65,780	83
6034, 6044	50	1,416	24	1,200	33,980	3,600	101,941	84

Tested with .002" (0.05mm) gap.



Model 6042 2" (51mm) Adjustable Air Amplifiers with swivel fittings cool inductively heated axles prior to installing the hubs.



Metal parts are dried using a series of Model 6042 2" (51mm) Adjustable Air Amplifiers.

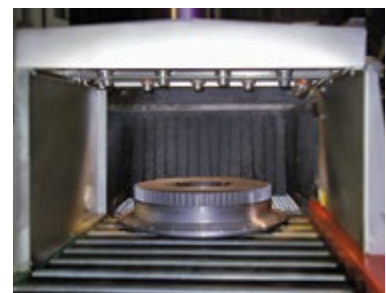

A series of Adjustable Air Amplifiers dry and cool a large machined casting as it exits a high temperature wash.

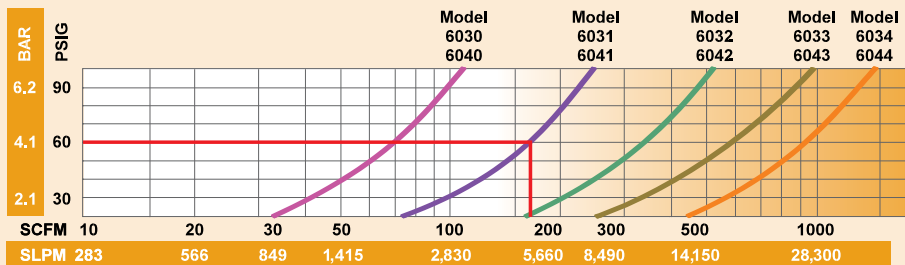

Total Output Flow with .002" (0.05mm) gap setting. Excludes downstream entrainment.

### How To Determine Adjustable Air Amplifier Total Output Flow And Air Consumption

**Total Airflow:** From the performance curves (above), determine total output flow for any Adjustable Air Amplifier at any pressure.

**Example:** A Model 6031 at 60 PSIG (4.1 BAR) supply air pressure has a total output flow of 165 SCFM (4,672 SLPM).

**Air Consumption:** Divide total output flow by the amplification ratio (shown in the chart) to determine air consumption for any Adjustable Air Amplifier at any air pressure.

In the example above, the Model 6031 at 60 PSIG (4.1 BAR) supply air pressure has a total output flow of 165 SCFM (4,672 SLPM). Dividing this total flow by its amplification ratio of 16 gives an air consumption of 10.3 SCFM (292 SLPM).

# Adjustable Air Amplifiers

## Adjustable Air Amplifier Dimensions

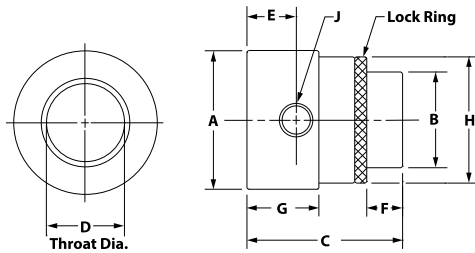

Air Amplifiers

Adjustable Air Amplifiers and High Velocity Air Jets dry an engine block prior to assembly.

Adjustable Air Amplifier Dimensions										
Model #		A	B	C	D	E	F	G	H	J
6030 6040	in	1.50	0.75	2.22	0.45	0.72	0.56	1.06	1.25	1/8 NPT
	mm	38	19	57	11	18	14	27	32	
6031 6041	in	2	1.25	2.88	0.84	1	0.75	1.38	1.75	1/4 NPT
	mm	51	32	73	21	25	19	35	44	
6032 6042	in	3.13	2	3.25	1.64	1.06	0.75	1.50	2.75	3/8 NPT
	mm	79	51	83	42	27	19	38	70	
6033 6043	in	4	3	4.06	2.20	1.22	1.25	1.83	3.50	1/2 NPT
	mm	102	76	103	56	31	32	46	89	
6034 6044	in	5	4	5	3.02	1.50	1.75	2.13	4.50	1/2 NPT
	mm	127	102	127	77	38	44	54	114	



## Need Swivels?

EXAIR's Swivel Fittings make it easy to adjust the aim of Air Amplifiers.

See page 68 for details.

## Adjustable Air Amplifier Systems

### Adjustable Air Amplifier Models

#### Adjustable Air Amplifier Only

**Adjustable Air Amplifier Kits** - include an Adjustable Air Amplifier, filter separator and pressure regulator (with coupler).

**Deluxe Adjustable Air Amplifier Kits** - include an Adjustable Air Amplifier, EFC, filter separator and pressure regulator (with coupler).

Outlet Diameter	Aluminum Adjustable Air Amplifier Only Model	Aluminum Adjustable Air Amplifier Kit Model	Deluxe Aluminum Adjustable Air Amplifier Kit Model	Stainless Steel Adjustable Air Amplifier Only Model	Stainless Steel Adjustable Air Amplifier Kit Model	Deluxe Stainless Steel Adjustable Air Amplifier Kit Model
3/4" (19mm)	6040	6240	6240DX	6030	6230	6230DX
1-1/4" (32mm)	6041	6241	6241DX	6031	6231	6231DX
2" (51mm)	6042	6242	6242DX	6032	6232	6232DX
3" (76mm)	6043	6243	6243DX	6033	6233	6233DX
4" (102mm)	6044	6244	6244DX	6034	6234	6234DX

## Airflow Pattern

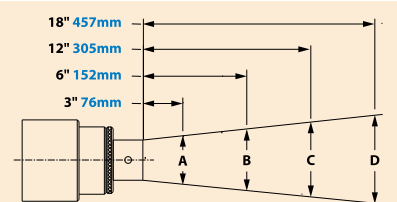

Model #		A	B	C	D
6030 6040	in	1.5	2.4	4.2	6
	mm	38	61	107	152
6031 6041	in	2	2.9	4.7	6.5
	mm	51	74	119	165
6032 6042	in	2.5	3.4	5.2	7
	mm	64	86	132	178
6033 6043	in	3.5	4.6	6.5	8
	mm	89	117	165	203
6034 6044	in	5	5.8	7.4	9
	mm	127	147	188	229

## Accessories

Model #	Description
9001	Auto Drain Filter Separator, 3/8 NPT, 65 SCFM (1,841 SLPM)
9032	Auto Drain Filter Separator, 1/2 NPT, 90 SCFM (2,549 SLPM)
9002	Auto Drain Filter Separator, 3/4 NPT, 220 SCFM (6,230 SLPM)
9005	Oil Removal Filter, 3/8 NPT, 15-37 SCFM (425-1,048 SLPM)
9006	Oil Removal Filter, 3/4 NPT, 50-150 SCFM (1,416-4,248 SLPM)
9008	Pressure Regulator with Gauge, 1/4 NPT, 50 SCFM (1,416 SLPM)
9033	Pressure Regulator with Gauge, 1/2 NPT, 100 SCFM (2,832 SLPM)
9009	Pressure Regulator with Gauge, 3/4 NPT, 220 SCFM (6,230 SLPM)



Kits include an Adjustable Air Amplifier, filter separator and pressure regulator (with coupler).



# EXAIR® Standards Compliance

As the leader in standards compliance, EXAIR's products come with more than engineered performance, peak efficiency, the best technical knowledge and unmatched customer service...

EXAIR is dedicated to providing products that have been manufactured to meet the strict requirements of the following standards. These standards provide confidence that you are receiving reliable, high quality products which will perform as stated within the performance charts provided.

Our products meet or exceed the strict safety standards of OSHA and the European Union to ensure the safety of your personnel. Many of these standards will allow your products a smoother transaction when selling your products into international markets.



## OSHA and CE Compliance:

EXAIR compressed air products comply with OSHA's Safety Requirements (29 CFR 1910.242(b) ), the EU General Product Safety Directive (2001/95/EC) and meet the noise limitation requirements (29 CFR-1910.95(a) ), of the EU Machinery Directive (2006/42/EC). EXAIR's Electronic Flow Control and Electronic Temperature Control meet the low voltage standards of the EU Low Voltage Directive (2006/95/EC). Some EXAIR products display the CE mark where there are applicable directives. All sound level measurements are taken at 3 feet from product.



## RoHS:

Electrical portions of EXAIR's Static Eliminators, EFC, ETC, Digital Flowmeter solenoid valves, and thermostats comply with the RoHS (Restriction of Hazardous Substances) Directive 2011/65/EU, including the amendment outlined in the European Commission decision L 214/65.



## Conflict Mineral Free:

Look for this symbol to designate conflict mineral free products throughout our catalog. EXAIR supports Section 1502 of the Dodd-Frank Wall Street Reform and Consumer Protection Act. We are committed to compliance with the conflict minerals rule in order to curb the illicit trade of tin, tantalum, tungsten and gold in the DRC region. EXAIR is using the CMRT 4.20 template to document our supply chain and commitment to conflict free products.



## Reach:

Per Regulation (EC) No 1907/2006 Title I, Article 3, paragraph 3, the European Union has recently enacted legislation to register chemicals and substances imported into the EU to ensure a high level of protection of human health and the environment.

Per Title II, Article 7, paragraph 1, articles (products) must be registered when a substance is intended to be released under normal or reasonably foreseeable conditions of use and it is present in those articles in quantities totaling over 1 metric ton per producer or importer per year. Registration of EXAIR products is not required since they do not contain substances that are intentionally released.

# Best Practices for Using **EXAIR** Intelligent Compressed Air™ Products



In order to achieve the best performance of your EXAIR Intelligent Compressed Air Product, a steady flow of compressed air must be supplied at the optimal pressure. Compressor output pressure, air flow rate, piping ID (inner diameter), the smoothness of the inside of the pipe, and connector type all contribute to the performance.

## Air Compressor Capability

Especially for manufacturing uses, it is important to consider both the air pressure and air flow being produced by the air compressor providing the supply for all tooling. It is possible for an air compressor to produce sufficient supply pressure for an EXAIR product while not having adequate air flow to use the product for very long!

## Air Pressure

The optimal operating pressure for most EXAIR products is 80 PSIG, with the exception of Vortex Tube based products, which are rated at 100 PSIG. Operating EXAIR products at air pressures less than 80 PSIG may lead to lower performance, but EXAIR encourages operating any blowoff product at as low a pressure as possible to achieve your desired result. A simple pressure regulator can lower your pressure and save energy. As a general rule near the 100 PSIG level, lowering air pressure by 2 PSIG will save 1% of energy used by an air compressor. Operating the product at pressures greater than 80 PSIG may produce slightly higher performance, but will require more energy to produce only a small gain.

## Connectors and Fittings

Make sure that connectors and fittings do not restrict compressed air flow in any manner. Quick connectors can be especially problematic in this area. Because of their construction, quick connections that are rated at the same size as the incoming pipe or hose may actually have a much smaller inner diameter than that associated pipe or hose. This will significantly restrict the amount of air that is being supplied to the tool, starving it of the air flow it needs for best performance. In some cases, if the fitting is too small, the tool may not work at all!

In most cases we do not recommend any of the fittings numbered 1-5. Our minimum recommendation is represented in numbers 6-9

1	2	3	4	5	6	7	8	9
1/8" tube x 1/4 NPT	1/8" tube x 1/4 NPT	1/8" tube x 1/4 NPT	1/8" tube x 1/4 NPT	1/8" tube x 1/4 NPT	1/8" tube x 1/4 NPT	1/8" tube x 1/4 NPT	1/8" tube x 1/4 NPT	1/8" tube x 1/4 NPT
1/8" I.D.	13/64" I.D.	1/4" I.D.	1/4" I.D.	1/4" I.D.	9/32" I.D.	9/32" I.D.	9/32" I.D.	11/32" I.D.

Not Recommended

Recommended



# Best Practices for Using **EXAIR** Intelligent Compressed Air™ Products

continued

## Proper Air Pipe Sizing

In addition to all of the items above, it is also important to select the proper compressed air pipe size from the compressor to the point of use. Because the inside of a pipe is not perfectly smooth, the volume of air will become more restricted as it passes through a greater distance, thus reducing the available pressure at the point of use. To compensate for this loss, a larger diameter pipe is needed for a longer run. The table below shows the typical pressure loss in pounds per square inch for 100 feet of 1" Schedule 40 pipe. For lengths other than 100 feet, the pressure drop is proportional to the ratio of difference in lengths. For instance, the pressure drop in 50 feet of pipe will be approximately one-half the value on the table.

1" Schedule 40 Pipe - 1.049 actual I.D.								
Free Air (SCFM)	Line Pressure (PSIG)							
	40	50	60	70	80	90	100	110
50	1.66	1.33	1.11	0.95	0.83	0.75	0.66	0.60
60	2.33	1.86	1.55	1.33	1.16	1.03	0.93	0.85
70	3.09	2.47	2.06	1.77	1.55	1.37	1.24	1.12
80	3.96	3.17	2.64	2.26	1.98	1.76	1.58	1.44
90	4.92	3.94	3.28	2.81	2.46	2.19	1.97	1.79
100	5.98	4.79	3.99	3.42	2.99	2.66	2.39	2.18
125	9.04	7.23	6.03	5.17	4.52	4.02	3.62	3.29
150	-	10.13	8.44	7.24	6.33	5.63	5.07	4.61
175	-	-	-	9.63	8.42	7.49	6.74	6.13
200	-	-	-	-	10.78	9.59	8.63	7.84
225	-	-	-	-	-	-	10.73	9.75

## How to Calculate Compressed Air Consumption

**Method 1**

Air consumption is directly proportional to absolute inlet pressure

$$\frac{SCFM_2}{SCFM_1} = \frac{P_2 + 1 \text{ atmosphere}}{P_1 + 1 \text{ atmosphere}}$$

Example: A Model 3215 Vortex Tube consumes 15 SCFM at 100 PSIG (425 SLPM @ 6.9 BAR). To calculate the airflow with an inlet pressure of 80 PSIG (5.5 BAR), the calculation is as follows:

**English Units:**

$$SCFM_2 = \frac{15 \times \frac{80 \text{ PSIG} + 14.7}{100 \text{ PSIG} + 14.7}}{1}$$

**Metric Units:**

$$SLPM_2 = \frac{424.752 \times \frac{5.156 \text{ BAR} + 1.014}{6.895 \text{ BAR} + 1.014}}{1}$$

**Method 2**

Multiply the known flow by the ratio of the input pressures converted to absolute

**Step 1:** Calculate the ratio of absolute inlet pressures.

<p><b>English Units:</b></p> $\frac{80 \text{ PSIG} + 14.7}{100 \text{ PSIG} + 14.7} = 0.8256$	<p><b>Metric Units:</b></p> $\frac{5.516 \text{ BAR} + 1.014}{6.895 \text{ BAR} + 1.014} = 0.8256$
--	--

**Step 2:** Multiply known flow by the above ratio you just calculated.

<p><b>English Units:</b></p> $15 \text{ SCFM} \times 0.8256 = 12.384 \text{ SCFM}$	<p><b>Metric Units:</b></p> $424.752 \text{ SLPM} \times 0.8256 = 350.693 \text{ SLPM}$
--	---

**Therefore**

Model 3215 consumes 15 SCFM @ 100 PSIG (425 SLPM @ 6.9 BAR) and will consume 12.4 SCFM @ 80 PSIG (351 SLPM @ 5.5 BAR).

Note: To convert SCFM to SLPM, multiply by the factor 28.3168

To convert PSIG to BAR multiply by the factor 0.0689

For more information on pipe sizing, pipe selection, conversion, and consumption, please visit our website at <https://exair.co/04-airdata> or scan this qr code provided.

